

**SPECIAL DETAIL
PAVEMENT CUT-ASPHALT**
N.T.S.

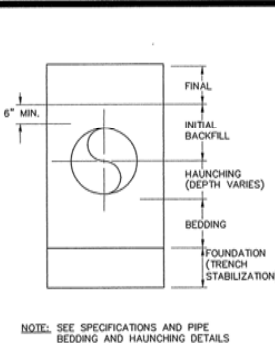

TRENCH TERMINOLOGY
N.T.S.

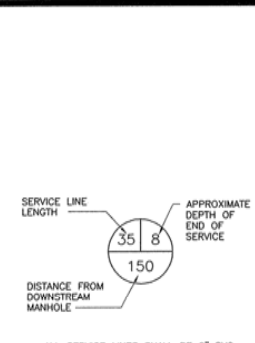

SEWER SERVICE SYMBOL
N.T.S.

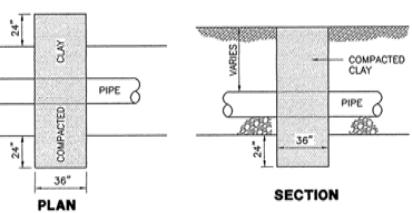

COMPACTED CLAY CHECK DAM
N.T.S.

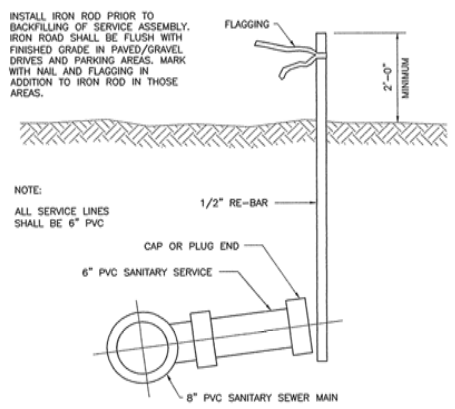

SERVICE CONNECTION DETAIL
N.T.S.

NOTE: CHECK DAMS SHALL BE INSTALLED AT LOCATIONS SHOWN ON DRAWINGS IN BEDDING AND BACKFILL. DAMS SHALL CONSIST OF COMPACTED CLAY BEDDING AND BACKFILL AT LEAST THREE (3) FEET THICK TO THE TOP OF THE TRENCH AND CUT INTO THE WALLS AND BOTTOM OF THE TRENCH TWO FEET. ALL STREAM CROSSINGS SHALL INCLUDE CHECK DAMS ON BOTH SIDES OF THE CROSSING.

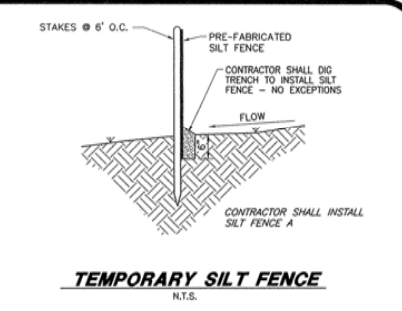
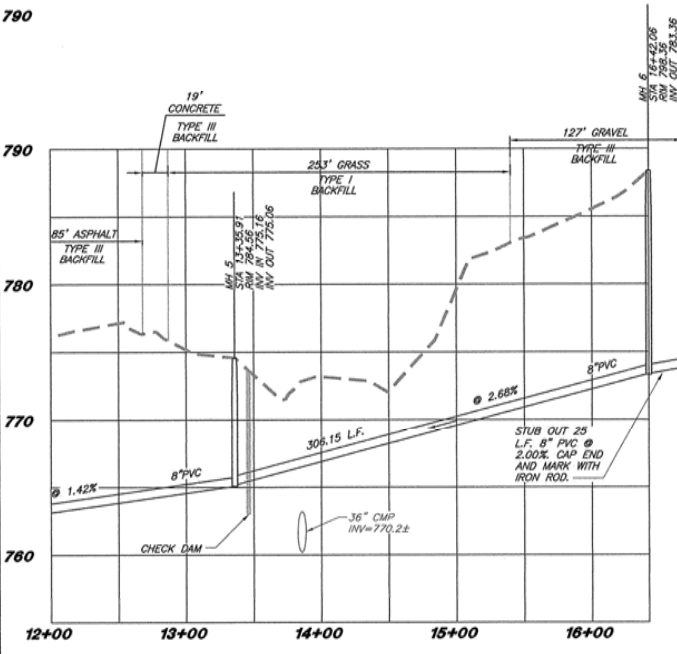
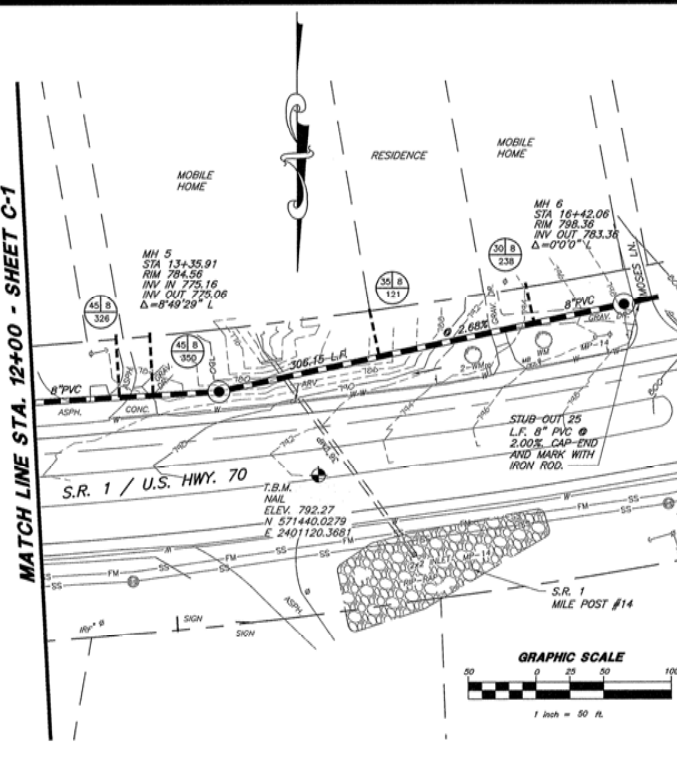

TEMPORARY SILT FENCE
N.T.S.

- GENERAL NOTES**
- OWNER: ROANE COUNTY ROANE COUNTY COURTHOUSE KINGSTON, TN PH. 865-378-5578
 - THE CONTRACTOR IS SPECIFICALLY CAUTIONED THAT THE LOCATION AND/OR ELEVATION OF EXISTING UTILITIES AS SHOWN ON THESE PLANS IS BASED ON RECORDS AND WHERE POSSIBLE MEASUREMENTS TAKEN IN THE FIELD. THIS INFORMATION IS NOT TO BE RELIED UPON AS BEING EXACT OR COMPLETE. THE CONTRACTOR MUST CALL TENNESSEE ONE CALL AND ANY UTILITY THAT DOES NOT SUBSCRIBE TO ONE CALL AT LEAST 72 HOURS BEFORE ANY EXCAVATION, TO REQUEST EXACT FIELD LOCATION OF THE UTILITIES. IT SHALL BE THE RESPONSIBILITY OF THE CONTRACTOR TO RELOCATE ALL EXISTING UTILITIES WHICH CONFLICT WITH THE PROPOSED IMPROVEMENTS SHOWN ON THE PLANS.
 - ALL LINES CONSTRUCTED UNDER PAVEMENT AND WITHIN 2' OF EDGE OF PAVEMENT SHALL BE BACKFILLED TO SUBGRADE WITH #57 STONE.
 - ALL TRENCHING AND SHORING SHALL COMPLY WITH OSHA STANDARDS.
 - ALL DISTURBED AREAS SHALL NOT SCHEDULED TO BE PAVED SHALL HAVE A MINIMUM OF 3 INCHES OF TOPSOIL PLACED ON THEM AND SHALL BE SEEDED AS SPECIFIED.
 - ALL CONSTRUCTION PRACTICES SHALL CONFORM TO THE TENNESSEE EROSION AND SEDIMENT CONTROL HANDBOOK. EROSION CONTROL DEVICES SHALL BE MONITORED DURING AND AFTER RAINFALL, WITH ANY MODIFICATIONS AND/OR REPAIR MADE AS SOON AS CONDITIONS PERMIT.
 - CONTRACTOR SHALL REMOVE AND DISPOSE OF ALL TEMPORARY EROSION CONTROL DEVICES AFTER ESTABLISHMENT OF PERMANENT VEGETATION.

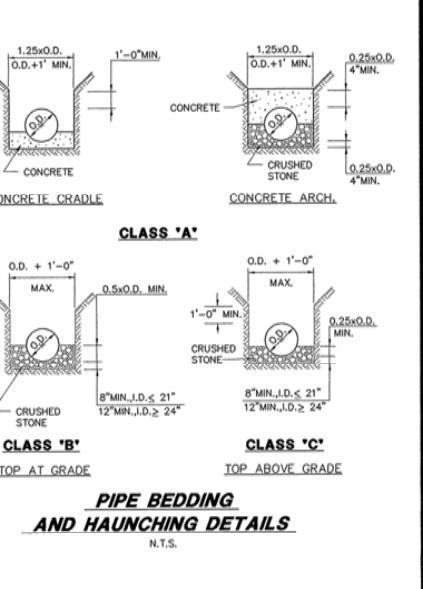
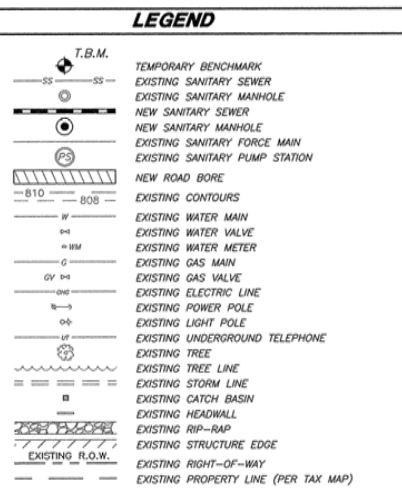

**PIPE BEDDING
AND HAUNCHING DETAILS**
N.T.S.

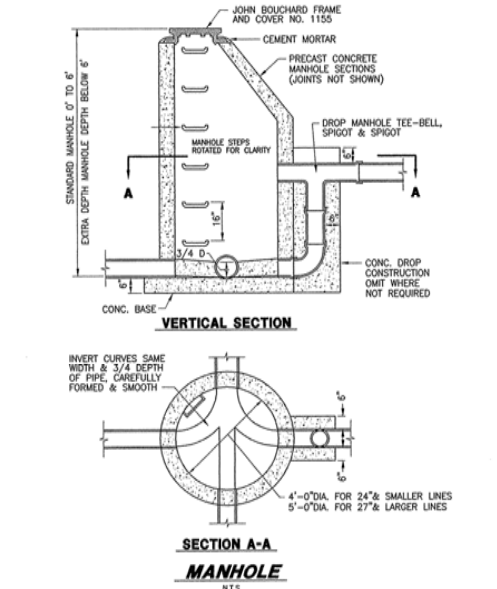

**SECTION A-A
MANHOLE**
N.T.S.

PROJECT: MDTOWN SANITARY
DRAWING DESCRIPTION: SANITARY SEWER
REVISION
NO. DATE
DRA
CHEC
APP
JOB
IN
V.
SC